

Article number: 54301405

Description: LDK Rod end PHS 5L
Threaded left

Measures

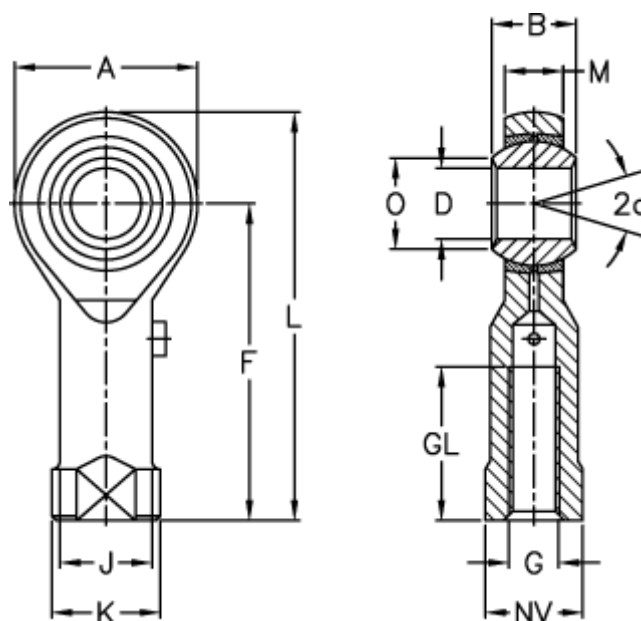

A	= 16	J	= 9.0
a (degrees)	= 13	K	= 11
B	= 8	L	= 35
D	= 5	M	= 6.00
Dynamic load C (kN)	= 2.5	NV	= 9
F	= 27	O	= 7.70
g	= M5	Static load C0 (kN)	= 8.1
GL	= 13	Weight (g)	= 16.5